

**Main Components**

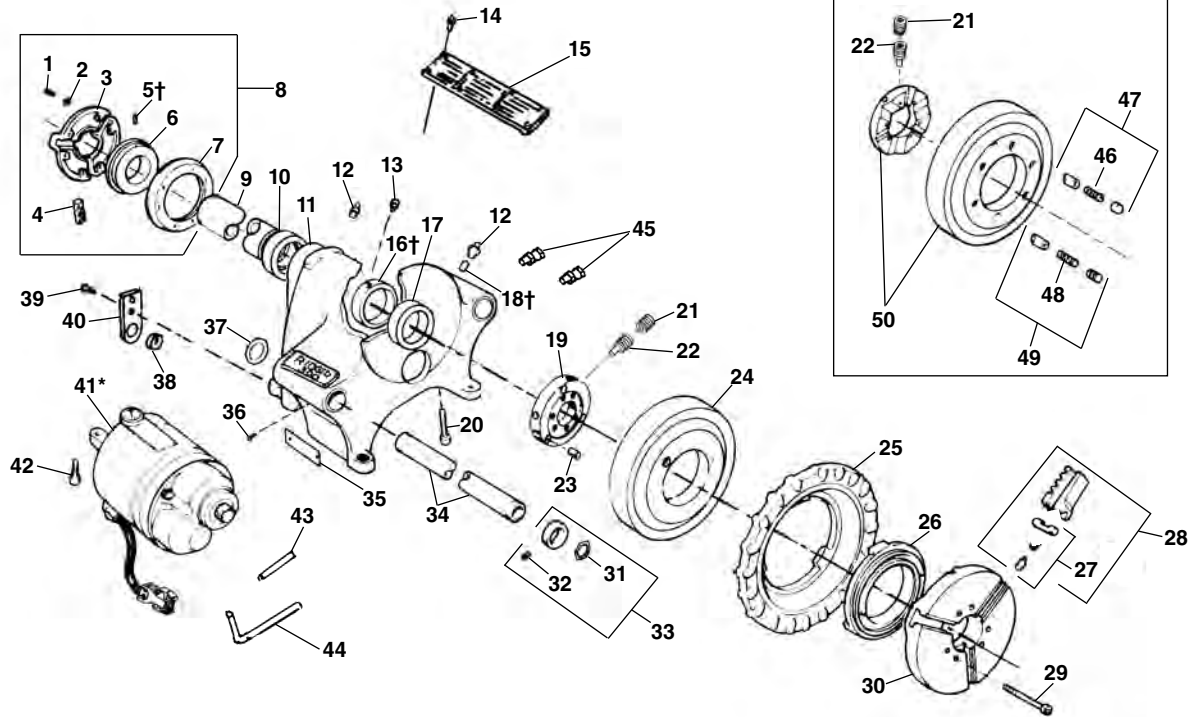

**NOTE: Order parts by Catalog Number only.  
DO NOT order by Reference Number.**

**For Information on Cutters, Die Heads and Reamers SEE INDEX**

Ref. No.	Catalog No.	Description	Ref. No.	Catalog No.	Description
1	46790	Screw, 12 - 24 x 3/4" (6)	27	44715	Jaw Insert Set
2	40270	Lock Washer (6)		97365	Jaw Insert Set F/Coated Pipe
3	43735	Centering Head	28	44090	Chuck Jaw Set
	19346	Centering Head (Europe)	29	45295	Screw 5/16" - 18 x 2 3/4" (6)
4	46500	Rear Jaw (3)	30	43525	Cap
5†	45260	Step Pin (3)	31	44720	Snap Ring (2)
6	44095	Scroll	32	46050	Set Screw 1/4" - 18 x 1/4" (2)
7	43740	Back Plate	33	44725	Ring Assembly (2)
	19356	Back Plate (Europe)	34	44425	Support Bar (Incl. Ref. No. 37)
8	44165	Rear Centering Assembly	35	90392	FOR/OFF/REV Label
9	44100	Drive Shaft	36	45280	Screw #8 - 32 x 5/8" (2)
10	45335	Rear Bearing-Bronze	37	44525	Spring Ring (2)
11	42845	300 Body Assembly (Incl. Ref. No. 10, 11, 12, 13, 14, 15, 17, 18, 38, 39, 40)	38	46735	Cord Grommet
	19056	300A Body Assy.- Europe (Incl. Ref. No. 10, 11, 12, 13, 14, 15, 17, 18, 38, 39, 40, 43, 44, 45)	39	44735	Screw 1/4" - 20 x 5/8" (2)
	96805	300A Body Assy. (Incl. Ref. No. 10, 11, 12, 13, 14, 15, 17, 18, 38, 39, 40, 43, 44, 45)	40	45825	Strain Relief Plate
12	46860	Grease Fitting	41*	87740	3177 Motor 115V (300)
13	33785	Set Screw 5/16" - 24 x 1/4" (2)		87780	3277 Motor 230V (300)
14	85920	Pop Rivet (10)		96810	3181 Motor 115V (300A)
15	88690	Warning Plate		96975	3281 Motor 230V (300A)
16†	45345	Thrust Ring		61202	3177-CE Motor 115V (300CE)
17	45270	Front Bearing		61207	3277-CE Motor 230V (300CE)
18†	45310	Split Roll Pin		61192	3181-CE Motor 230V (300A CE)
19	30027	Drive Ring, Type II		61197	3281-CE Motor 115V (300A CE)
20	46035	Screw 5/16" - 18 x 1 3/4"	42	46745	Screw 3/8" - 16 x 1 1/4" (2)
21	45300	Set Screw 5/16" - 24 x 1/4" (2)	43	96850	Tubing (300A)
22	45265	Set Screw 5/16" - 24 x 1/2" (3)	44	96855	Tubing (300A)
23	30022	Drive Pin, Type II (3)	45	96860	Bulkhead Union (2) (300A)
24	30017	Ring Gear, Type II	46	44310	Drive Spring (3)
25	89150	Hand Wheel	47	91552	Drive Wedge Kit
26	43540	Scroll	48	45285	Pressure Spring (3)
			49	91557	Plunger Kit
			50	91562	Conversion Kit (Includes Ref. Nos. 19-24)

\* Refer to Motor Model No. for Component Parts

**Service Notes:**

†Ref. 5 Stop Pins are easily removed by pushing from inside to outside.

†Ref. 18 Before removing front bearing sleeve (Ref. No. 17), dowel pin and grease fitting must be pushed out from inside.

†Ref. 16 Position thrust ring so that offset screw holes are closer to chuck.

## Main Drive Components

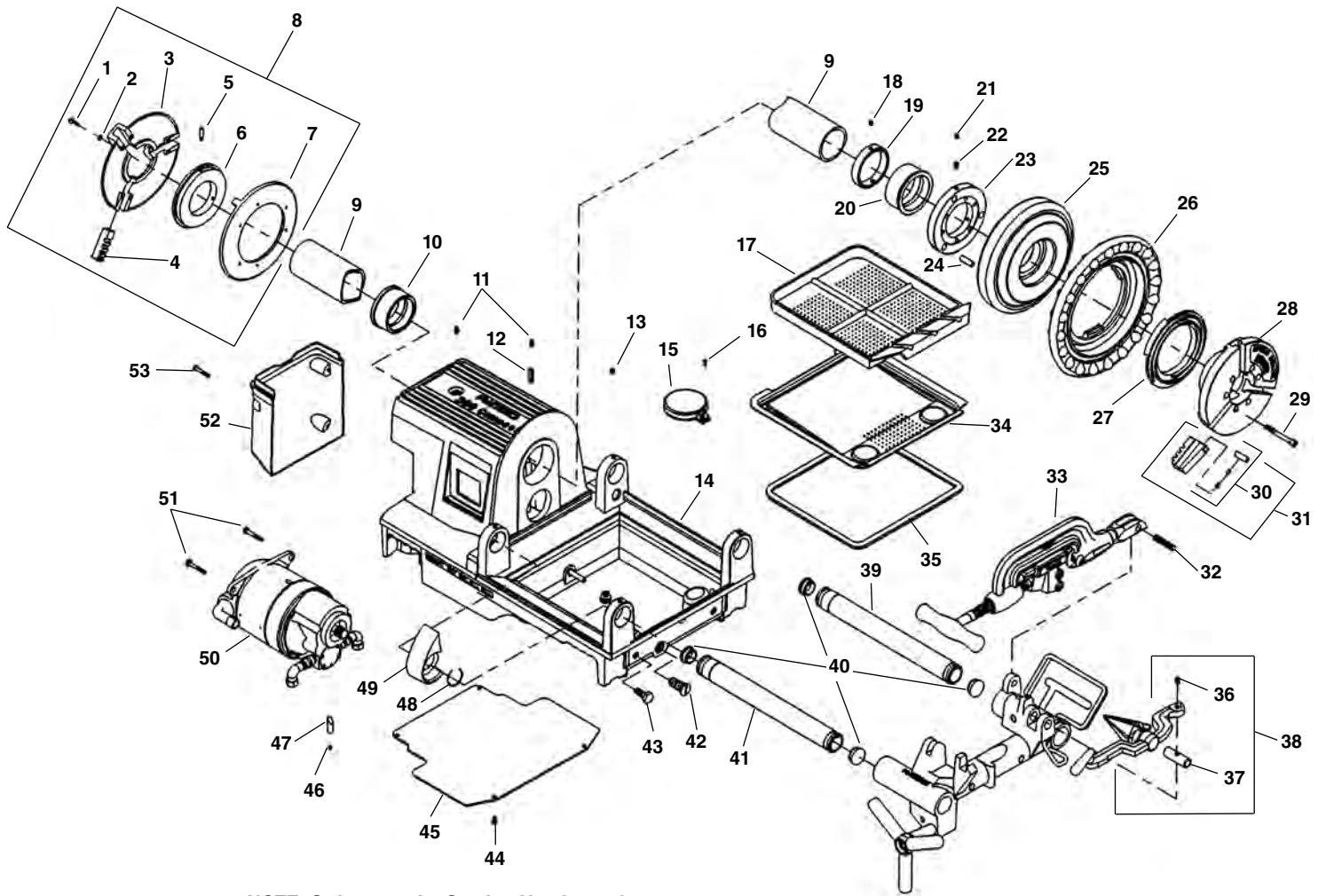

**NOTE: Order parts by Catalog Number only.  
DO NOT order by Reference Number.**

Ref. No.	Catalog No.	Description	Ref. No.	Catalog No.	Description
1	46790	Screw 12 - 24 x 3/4" (6)	28	43525	Chuck Cap
2	40270	Lock Washer (6)	29	45295	Screw 5/16" x 2 3/4" (6)
3	43735	Rear Centering Head	30	44715	Jaw Insert Set (3)
	19346	Rear Centering Head (Europe)		97365	Jaw Insert Set f/Coated Pipe (3)
4	46500	Rear Jaw	31	44090	Chuck Jaw Set
5	45260	Step Pin	32	45520	Hinge Pin
6	44095	Scroll	33	42370	360 Cutter Complete
7	43740	Back Plate	34	54052	Oil Pan Liner
	19356	Back Plate (Europe)	35	75632	Oil Pan Liner Gasket
8	44165	Rear Centering Assembly	36	36262	Shoulder Screw
9	44100	Drive Shaft	37	36267	Pivot Pin
10	45335	Rear Bearing	38	34612	344 Reamer
11	46860	Grease Fitting (2)	39	54112	Rear Rail
12	45310	Pin Split Roll	40	35162	Rail Plug (4)
13	60025	Set Screw 5/16" - 18 (4)	41	54117	Front Rail
14	54522	Base Export	42	54302	Drain Plug
	76342	Base N.A.	43	54042	M10-1.5 Hex Hd. Cap Screw
15	58467	Filter Screen Assembly	44	87730	Screw 1/4" x 3/8" (4)
16	45420	Screw 10 - 24 x 3/8"	45	61937	Bottom Cover
17	54047	Chip Tray	46	77905	Set Screw 5/16" x 1/4"
18	33785	Set Screw 5/16" x 24 x 5/16" (3)	47	54037	Motor Wedge
19	45345	Thrust Ring	48	87620	Retaining Ring
20	54502	Front Bearing	49	54507	Carriage Stop
21	45300	Set Screw 5/16" x 24 x 1/4" (3)	50	54797	Model 2192, 115V
22	45265	Set Screw 5/16" x 24 x 1/2" (3)		54802	Model 2292R, 230V
23	30027	Drive Ring		74182	Model 2199R, 115V, 52 RPM
24	30022	Drive Pin (3)	51	85915	Motor Mounting Bolt (2)
25	30017	Ring Gear	52	61932	Motor Cover
26	89150	Hand Wheel	53	54532	Motor Cover Screw (4)
27	43540	Chuck Scroll			

## Drive Shaft

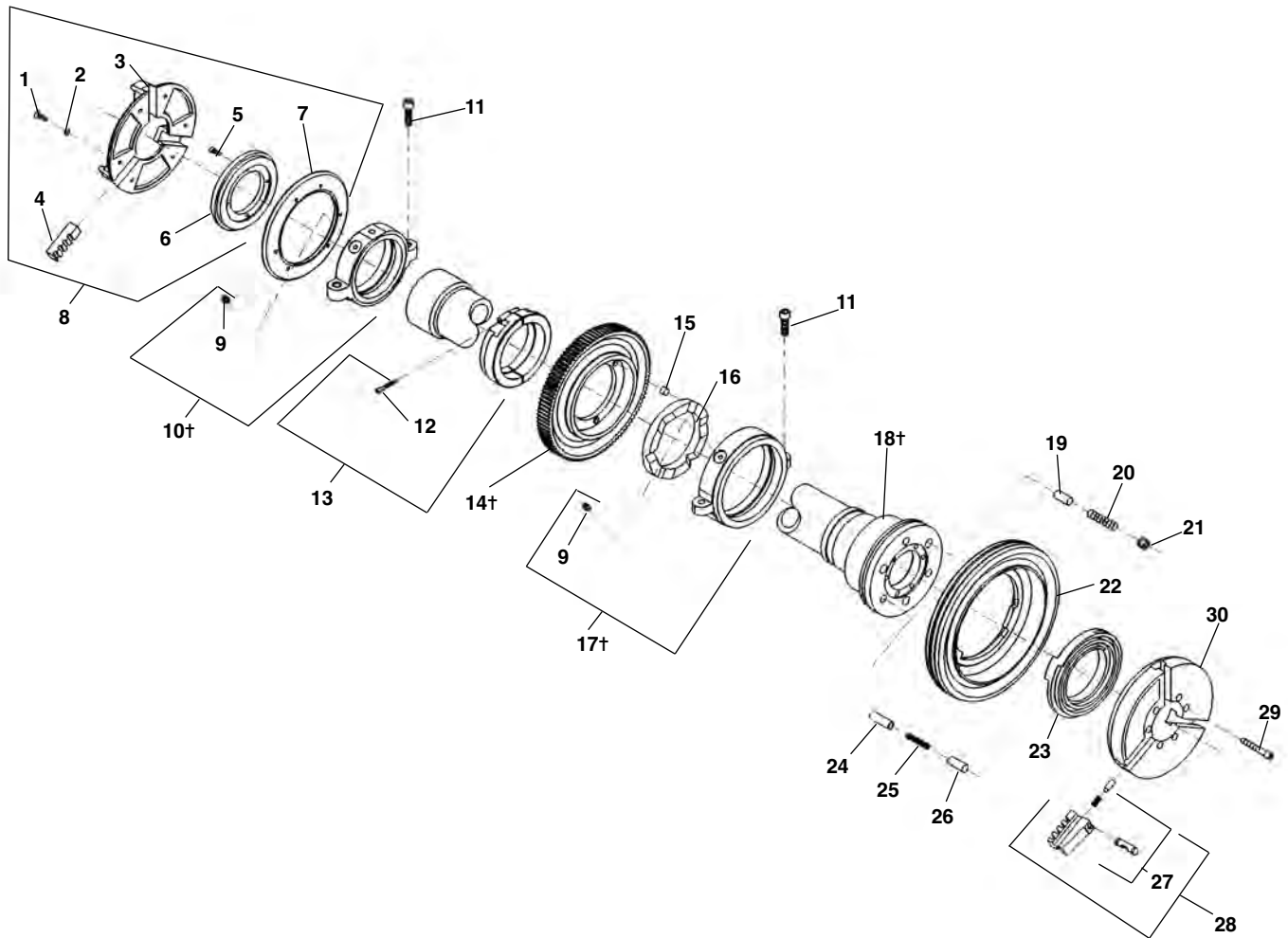

**NOTE: Order parts by Catalog Number only.  
DO NOT order by Reference Number.**

Ref. No.	Catalog No.	Description	Ref. No.	Catalog No.	Description
—	47585	Drive Shaft Assembly	15	44490	Drive Plug (3)
1	46790	Screw (6)	16	43895	Pressure Plate
2	40270	Lock Washer (6)	17†	43455	Front Bearing Assembly
3	43735	Centering Head	18†	43105	Drive Shaft
	19346	Centering Head (Europe)	19	44320	Pressure Plunger (3)
4	46500	Centering Jaw Set	20	44325	Pressure Spring (3)
5	46765	Screw 10 – 32 x 1/2"	21	44330	Pressure Set Screw (3)
6	43750	Scroll	22	43420	Handwheel
7	43740	Back Plate	23	43450	Scroll
	19356	Back Plate (Europe)	24	44315	Drive Wedge
8	47570	Centering Head Assembly	25	44310	Drive Spring
9	46860	Grease Fitting	26	44305	Drive Cap
10†	41338	Rear Bearing Assembly	27	44715	Jaw Insert Set
11	46745	Screw 3/8" – 16 x 1 1/4" (4)		97365	Jaw Insert Set f/Plas. Coated Pipe
12	90255	Screw 10 – 32 x 1 1/4"	28	43900	Chuck Jaw Set
13	83525	Split Ring Assembly	29	45160	Screw 7/16" – 18 x 2" (6)
14†	43460	Drive Gear	30	43440	Chuck Cap

† Service Notes: Ref. Nos. 14 & 18 - When installing gear on shaft, align "O" mark on front of gear with "O" mark on the rear of the drive shaft flange.

Ref. Nos. 11 & 17 - When replacing the front or rear bearing brackets, position grease fittings toward the operator's side of the machine.